



**CLINICAL GUIDELINES:  
PMTCT (Prevention of Mother-to-  
Child Transmission)**

**2010**

**National Department of Health, South Africa;  
South African National AIDS Council**



## **FOREWORD**

It is with pleasure that I present the revised PMTCT Guidelines.

Government has adopted a new outcomes based approach to accelerate attainment of the objectives outlined in the Medium Term Strategic Framework (MTSF) 2009-2014. One of the objectives is to improve the health profile of all South Africans.

The 10 point plan of the Health Sector is aimed at creating a well functioning health system capable of producing improved health outcomes. Priority seven of the 10 point plan is to accelerate implementation of the HIV&AIDS plan and the reduction of mortality due to TB and associated diseases.

On World AIDS Day, 2009, the Honourable President Jacob Zuma announced new interventions to improve antiretroviral therapy (ART) access for priority groups in order to decrease the disease burden, to address maternal and child mortality, and to improve life expectancy.

Based on the Presidential announcements, all HIV positive pregnant women with a CD4 count  $350/\text{mm}^3$  will commence lifelong ART earlier, or less furthermore, prophylaxis ART treatment will be started earlier, at 14 weeks pregnancy, for women who are not eligible for lifelong ART. For the first time, HIV positive women can safely breastfeed their children provided the child is taking ARV's during the breastfeeding period.

This document serves as a new guide to health practitioners with regard to the comprehensive management of pregnant women who are HIV positive.

It is of paramount importance to note that PMTCT has the potential to be the engine for strengthening delivery of comprehensive, integrated health care. The guideline therefore, promotes the integration of PMTCT with maternal, newborn and child health provision of, ART, family planning, STI and TB services.

The many comments from and the involvement of internal and external stakeholders is appreciated and has contributed significantly to the finalization of these guidelines. I would like to thank all who contributed to the development of these guidelines despite their busy schedules.

**DR AARON MOTSOALEDI**

**MINISTER OF HEALTH**

**DATE:**

## ABBREVIATIONS AND ACRONYMS

3TC	Lamivudine
ANC	Antenatal Care
AIDS	Acquired Immune Deficiency Syndrome
ALT	Alanine Aminotransferase
ART	Antiretroviral Therapy
ARV	Antiretroviral
ART	Antiretroviral Therapy
AZT	Zidovudine
BANC	Basic Antenatal Care
BF	Breast Feeding
BFHI	Baby Friendly Hospital Initiative
BBA	Born Before Arrival (to delivery unit)
CCMT	Comprehensive Care Management and Treatment for HIV and AIDS
CHW's	Community Health Workers
CTX	Cotrimoxazole
DNA	Deoxyribonucleic Acid
d4T	Stavudine
ECD	Early Childhood Development
EBF	Exclusive Breastfeeding
EFF	Exclusive Formula Feeding
EFV	Efavirenz
EPI	Expanded Programme on Immunisation
FTC	Emtracitabine
HAART	Highly Active Antiretroviral Therapy
HCW	Health Care Worker
HIV	Human Immunodeficiency virus
IMCI	Integrated Management of Childhood Illness
LPV/r	Lopinovir/ritonavir
MTCT	Mother-to-Child Transmission of HIV
NHA	National Health Act
NHC	National Health Council
NSP	National Strategic Plan
NVP	Nevirapine
PEP	Post-Exposure Prophylaxis
PCP	<i>Pneumocystis jiroveci</i> Pneumonia
PCR	Polymerase Chain Reaction
PICT	Provider-Initiated HIV Counselling and Testing

PMTCT	Prevention of Mother-to-Child Transmission of HIV
PNC	Postnatal Care
RF	Replacement Feeding
RTHC	Road to Health Chart
sdNVP	Single-Dose Nevirapine
SRH	Sexual and Reproductive Health
TC	Testing and Counselling
TDF	Tenofovir
UNAIDS	United Nations Programme on HIV/AIDS
UNICEF	United Nations Children's Fund
VCT	Voluntary Counselling and Testing
WHA	World Health Assembly
WHO	World Health Organisation

## **DEFINITIONS**

### **Breast milk substitute**

Any food or drink marketed or otherwise representing a partial or total replacement for breast milk, whether or not suitable for that purpose.

### **Commercial infant formula**

A commercial product that meets the applicable Codex standard for infant formula, follow-up formula, and infant or follow-up formula for special dietary or medical purposes.

### **Complementary foods**

Refers to any foodstuff, whether in solid or semi-solid form, given to an infant after the age of 6 months as part of the transitional process in which an infant learns to eat food appropriate for his or her developmental stage, while continuing to breastfeed or be fed with commercial formula.

### **Cup feeding**

The act of feeding an infant or child using a cup, regardless of what the cup contains.

### **Exclusive breastfeeding or exclusive breast milk feeding**

Feeding practice in which an infant receives only breast milk and no other liquids or solids, including water, but may receive drops or syrups consisting of vitamins, mineral supplements, or medicines that are deemed necessary and essential for the child. When expressed milk is given, the preferred term is breast milk feeding.

### **Exclusive formula feeding**

Feeding practice in which infants receive no breast milk, but receive a diet that provides adequate nutrients until the age at which they can be exclusively fed family foods. During the first 6 months of life, formula feeding requires a suitable commercial formula. After 6 months, complementary foods should be introduced.

### **Health care personnel**

Health care providers and health care workers.

### **Health care provider**

Any person providing health services in terms of any law, including in terms of the:

- Allied Health Professions Act, 1982 (Act No.63 of 1982)
- Health Professions Act, 1974 (Act No. 56 of 1974)
- Nursing Act, 1978 (Act No. 53 of 1974)
- Pharmacy Act, 1974 (Act No. 53 of 1974) and
- Dental Technicians Act, 1978 (Act No. 19 of 1979)

**Health care worker**

Any person who is involved in the provision of health services to a user, but is not a health care provider as defined above. This includes lay counsellors and community caregivers.

**HIV-exposed infant:**

Infant born to an HIV-positive woman.

**HIV-negative**

Refers to people who have taken an HIV test with a negative result and know their result.

**HIV-positive**

Refers to people who have taken an HIV test with a positive result and know their result.

**HIV status unknown**

Refers to people who have not taken an HIV test or who do not know the result of their test.

**Infant**

A person from birth to 12 months of age.

**Micronutrients**

Micronutrients are natural substances found in small amounts in food (e.g. vitamins and minerals), as compared with macronutrients (e.g. protein, fats and carbohydrates), which are found in larger amounts.

**Mixed feeding**

Feeding breast milk as well as other milks (including commercial formula or home-prepared milk), foods, or liquids.

**Mother-to-child transmission**

Transmission of HIV from an HIV-positive woman to her child during pregnancy, delivery, or breastfeeding. The term is used because the immediate source of the infection is the mother, and does not imply blame on the mother.

**Nutritional status**

An individual's state as determined by anthropometric measures (height, weight, circumference etc.), biochemical measures of nutrients or their by-products in blood and urine, a physical (clinical) examination, and a dietary assessment and analysis.

**Nutritional supplements**

Food- and / or nutrient- supplements given in addition to food available at home.

**Provider-initiated counselling and testing (PICT)**

A routine, opt-out process in which health care personnel offer group information and HIV-testing,

with the patient / client always retaining the option to decline. The patient / client also receives post-refusal counselling or post-test counselling.

**Replacement feeding**

Feeding of infants who are receiving no breast milk with a diet that provides adequate nutrients until the age at which they can be exclusively fed on full family foods. During the first 6 months of life, formula feeding should be with a suitable commercial formula. After 6 months, complementary foods should be introduced.

**Safe infant feeding**

Feeding practices that would lead to a healthy, well-grown, able, live, HIV-free child who has no underlying morbidity resulting from incorrect feeding practices.

## TABLE OF CONTENTS

FOREWORD.....	1
ABBREVIATIONS AND ACRONYMS.....	2
DEFINITIONS .....	4
1. EXECUTIVE SUMMARY .....	8
2. PMTCT PROCESSES AND GOALS OF INTERVENTION.....	10
2.1 ANTENATAL CARE .....	10
2.2 LABOUR AND DELIVERY .....	10
2.3 POSTNATAL FOLLOW-UP OF MOTHER AND INFANT.....	11
3. KEEPING WOMEN AND CHILDREN HEALTHY AND IMPROVING THEIR QUALITY OF LIFE AND REDUCING MORTALITY.....	14
4. PROVIDER-INITIATED COUNSELLING AND TESTING.....	16
4.1 OVERVIEW.....	16
4.2 TESTING ALGORITHM FOR PREGNANT WOMEN .....	18
4.3 POST-TEST COUNSELLING.....	21
5. ROUTINE CLINICAL CARE FOR HIV-POSITIVE PREGNANT WOMEN.....	24
5.1 ANTENATAL MANAGEMENT .....	24
INITIAL ASSESSMENT .....	24
ANITRETROVIRAL PROPHYLAXIS .....	25
LIFELONG ANTIRETROVIRAL TREATMENT .....	25
SPECIAL CIRCUMSTANCES:.....	26
5.2 INTRAPARTUM MANAGEMENT .....	27
ANTIRETROVIRAL PROPHYLAXIS .....	27
ANTIRETROVIRAL TREATMENT .....	27
INTRAPARTUM SPECIAL CIRCUMSTANCES .....	27
5.3 SAFE DELIVERY TECHNIQUES.....	27
5.4 POSTNATAL CARE .....	27
CARE OF HIV-POSITIVE WOMEN AND THEIR INFANTS IN THE IMMEDIATE POST-DELIVERY PERIOD .....	27
ANTIRETROVIRAL PROPHYLAXIS .....	28
INFANT PROPHYLAXIS .....	28
6. REGIMENS.....	30
7. ESTABLISHING SAFE INFANT FEEDING PRACTICES.....	32
7.1 BACKGROUND.....	32
8. INFANT FOLLOW-UP.....	35
9. REFERENCES .....	37

### Tables and Figures

Figure 1: Summary of PMTCT Processes.....	10
Figure 2: PMTCT Algorithm.....	11
Figure 3: Infants who are exclusively formula fed.....	12
Figure 4: Infants who are exclusively breastfed whose mothers are on lifelong ART.....	12
Figure 5: Infants who are exclusively breastfed whose mothers are NOT on lifelong ART.....	13
Figure 6: All mothers at scheduled check-up, 6 weeks post-partum.....	13
Figure 7: Provider-initiated counselling and testing.....	17
Figure 8: Algorithm for HIV testing: .....	20



## 1. EXECUTIVE SUMMARY

This document is an update of the national PMTCT Policy and Guidelines. It aims to provide continued guidance towards a reduction in the vertical transmission of HIV, building on work done since the inception of the programme and the 2008 Policy and Guidelines document.

In line with the international standards for a comprehensive strategy, the PMTCT policy recognises that in order to prevent HIV among women and children, the four elements of PMTCT are integral. These include:

- Primary prevention of HIV, especially among women of childbearing age;
- Preventing unintended pregnancies among women living with HIV;
- Preventing HIV transmission from a woman living with HIV to her infant; and
- Providing appropriate treatment, care, and support to women living with HIV and their children and families.

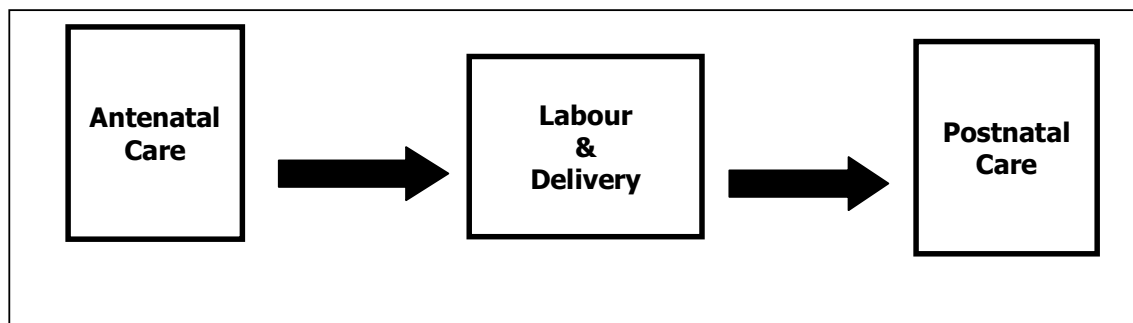
The National PMTCT programme aims to ensure:

- **Primary prevention** of HIV, especially among women of child-bearing age.
- **Integration of PMTCT interventions** with basic antenatal care (BANC), sexual and reproductive health (SRH), Child and Adolescent Health, CCMT and TB services.
- **Strengthening postnatal care** for the mother-baby pair.
- **Provision of an expanded package** of PMTCT services, including:
  - Routine offer of HIV counselling and testing for all pregnant women attending antenatal care
  - Provision of provider-initiated counselling and testing services in the context of PMTCT, in facilities offering routine antenatal care.
  - Involvement of the partner and the family in order to ensure a comprehensive approach.
  - Provision of appropriate regimens to prevent mother-to-child transmission of HIV according to the risk profile based on the HIV test, CD4 cell count, and clinical staging.
  - Provision of other appropriate treatments, such as those for opportunistic infections (OI) management and nutritional support.
  - Provision of psychosocial support to HIV-positive pregnant women.
  - Provision of quality, objective, and individualized counselling on safe infant feeding practices (as defined in this document) for HIV-positive women in health facilities offering routine ANC services, through trained lay counsellors and health care professionals.
  - Strengthened obstetric practices which reduce MTCT.
  - Provision of antiretroviral prophylaxis to infants.

- Integrated follow-up of infants born to HIV-positive women through routine child health services and the Integrated Management of Childhood Illness (IMCI) Strategy.
- Early infant HIV testing using HIV DNA-PCR at 6 weeks of age for all infants born to HIV-positive women (integrated with the EPI 6-week visit), irrespective of feeding option.
- Strengthening of community-based household and door-to-door activities to educate and enhance the utilization rates and effectiveness of health programs.

## 2. PMTCT PROCESSES AND GOALS OF INTERVENTION

*Figure 1: Summary of PMTCT Processes*



### 2.1 ANTENATAL CARE

#### Goals of interventions:

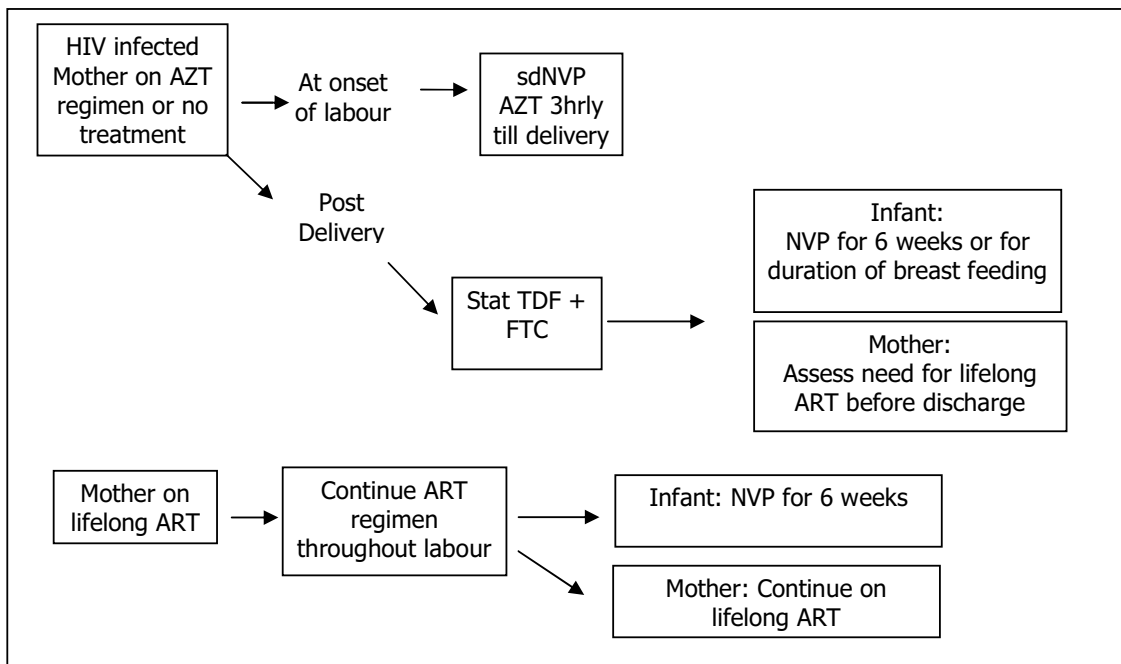
- Improve the quality of the mother's health and prevent mortality
- Identify women who are HIV-positive
- Ensure HIV-positive women enter the PMTCT programme
- Prevent mother-to-child transmission
- Provide AZT from 14 weeks of pregnancy or lifelong ART as soon as possible, depending on a mother's clinical indications

### 2.2 LABOUR AND DELIVERY

#### Goals of interventions:

- Identify HIV-positive women
- Provide adequate PMTCT coverage
- Continuity of care of prophylactic and treatment antiretroviral regimens
- Reduce maternal nevirapine resistance
- Initiate neonates born to HIV-positive mothers with antiretroviral prophylaxis immediately at birth

**Figure 2: PMTCT Algorithm**



*All women of unknown HIV status should be offered HIV testing and counselling before discharge, preferably prior to, or immediately after, delivery to ensure that the baby gets antiretroviral prophylaxis if the test is HIV positive.*

- *All abandoned infants judged to be in their first 72 hours of life should be given NVP as soon as possible and then daily for six weeks, or until rapid testing of the mother or infant confirms the absence of HIV exposure*
- *Breastfed infants whose mothers are not on lifelong ART should continue NVP beyond 6 weeks of age until all cessation of breastfeeding*

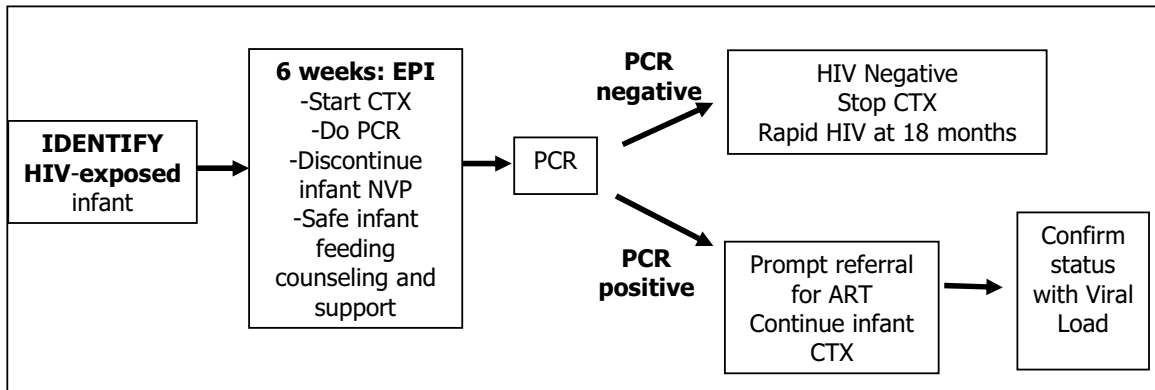
### **2.3 POSTNATAL FOLLOW-UP OF MOTHER AND INFANT**

#### **Goals of interventions:**

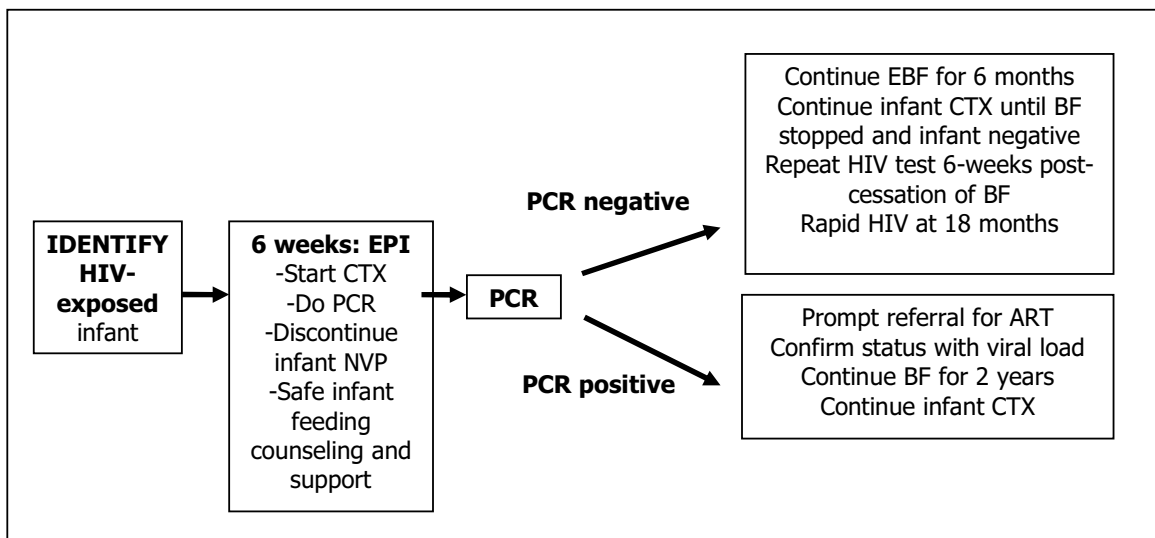
- Provide follow-up post-partum care including a postnatal visit within 3 days
- Improve the quality of the mother's health and reduce mortality by including family planning counselling and cervical cancer screening where applicable
- Provide post-exposure prophylaxis for infants

- Reduce postnatal HIV transmission through breastfeeding
- Identify all HIV-exposed infants
- Reduce mortality in HIV-exposed infants
- Identify all HIV-positive infants *and* start ART early

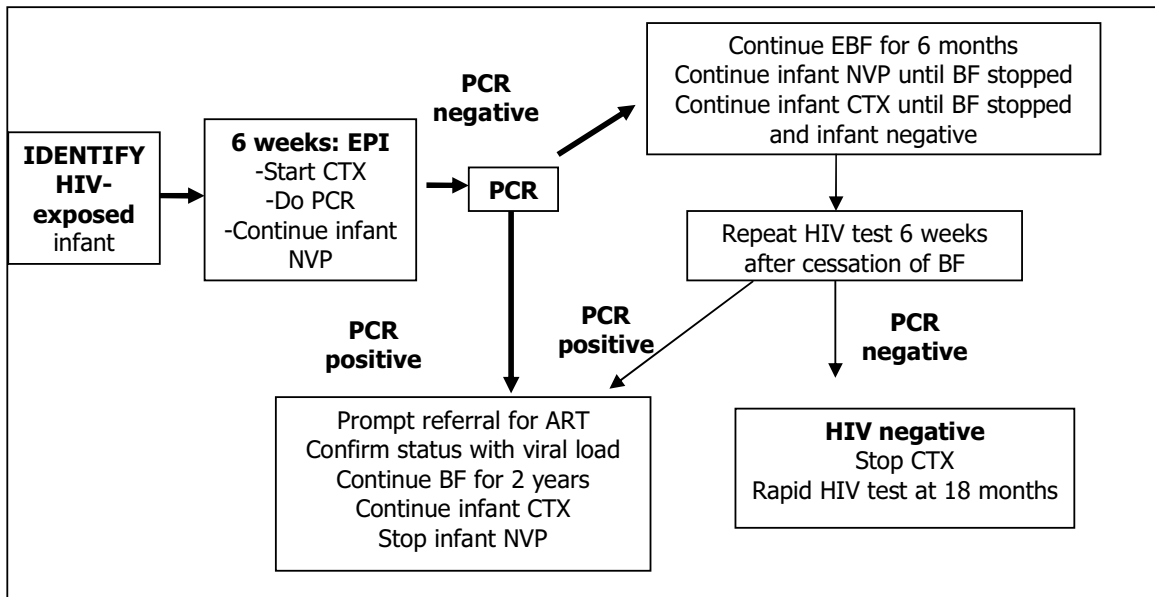
*Figure 3: Infants who are exclusively formula fed*



*Figure 4: Infants who are exclusively breastfed whose mothers are on lifelong ART*

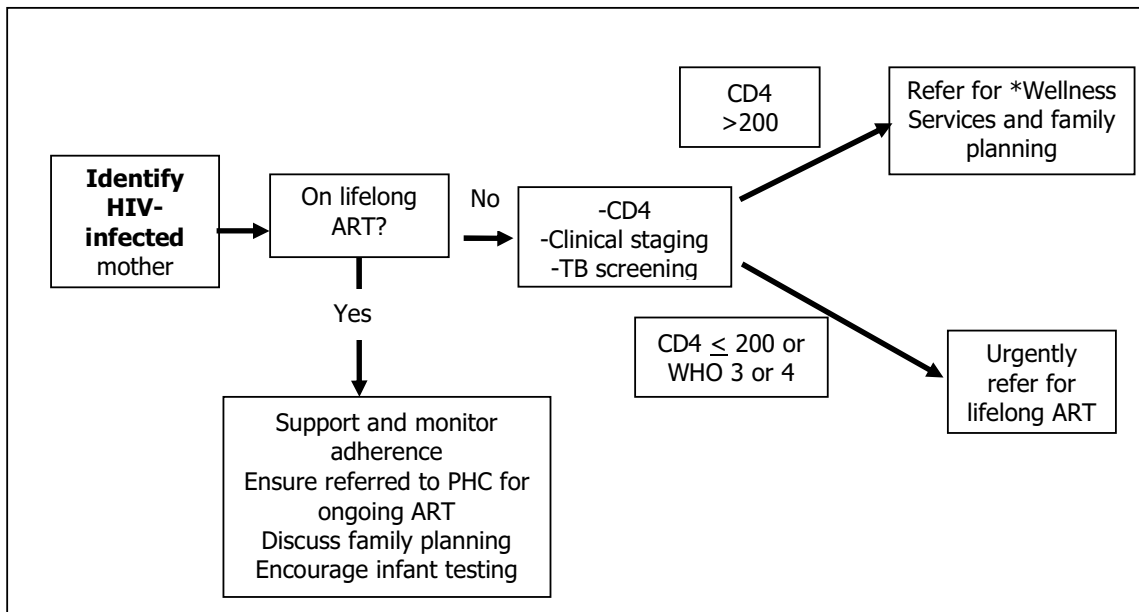


**Figure 5: Infants who are exclusively breastfed whose mothers are NOT on lifelong ART**



NB: All HIV-exposed infants not on ART should have a rapid test at 18 months of age to confirm HIV status conferred by the 6-week PCR test.

**Figure 6: All mothers at scheduled check-up, 6 weeks post-partum**



\* Wellness Services entails follow-up of HIV-infected individuals not yet on ART and includes: provision of TB screening, INH prophylaxis, CTX prophylaxis, nutritional and psychosocial support, cervical cancer screening, monitoring of CD4 cell count, clinical staging and preparedness for ART.

Mothers of unknown HIV status or who are HIV negative should be offered an HIV test during postnatal care visits.

### 3. KEEPING WOMEN AND CHILDREN HEALTHY AND IMPROVING THEIR QUALITY OF LIFE AND REDUCING MORTALITY

#### All pregnant women should:

- Be encouraged to book early into antenatal care, as soon as they believe they are or are confirmed to be pregnant.
- Receive routine antenatal care, including micronutrient supplementation.
- Be offered information on the availability of PMTCT interventions during all health care consultations.
- Be routinely offered HIV counselling and testing and encourage partner or spouse testing.
- Be encouraged to involve partners or spouses in caring for the pregnancy.
- Be counselled on safer sex and provided with condoms.
- Be counselled on safe infant feeding options and assisted in making an appropriate feeding choice.
- Be supported on the choice of infant feeding at all times.

#### All pregnant women who are HIV-positive should:

- Receive routine antenatal care, including iron and folate supplementation.
- Be offered information on the availability of PMTCT interventions at all health care consultations, and not only when visiting the antenatal clinic.
- Be clinically staged and have a CD4 cell count taken on the same day as the HIV test is done, and preferably at the first ANC visit (or at the earliest opportunity).
- Be screened for TB, in line with the BANC.
- Be screened and treated swiftly for syphilis and other STIs, in line with BANC.
- Receive regimens to prevent mother-to-child transmission of HIV (**PMTCT regimen**) OR lifelong ART if CD4 cell count  $\leq 350$  cells/mm<sup>3</sup> (**ART regimen**).
- Be offered appropriate PCP and TB prevention prophylaxis.
- Be counselled on safer sex, family planning, postnatal contraception and partner testing.

Women who **start lifelong ART in their pregnancy** should be monitored and managed, where possible, by the same provider in the same facility. They should receive follow-up from an antenatal healthcare worker **until at least 6 weeks postpartum**, before being referred for ongoing care to an appropriate facility.

**Women who test HIV-negative** should receive post-test counselling and counselling on risk reduction interventions including involvement of partners or spouses, focusing mainly on how to maintain their HIV-negative status. They should continue to receive routine antenatal care, and should be encouraged to use condoms. They should be offered a repeat HIV test at or around 32 weeks gestation, to detect those who may have sero-converted during pregnancy.

**Women who choose not to be tested** should receive individual ‘post-refusal’ counselling and be offered HIV testing at every subsequent visit in a non coercive manner during the antenatal period. They should also be offered an HIV test at the onset of labour; if this is not possible, they should be offered testing shortly after childbirth.

**Women who initially test negative and subsequently test positive during pregnancy** should be given a CD4cell count test, clinically staged, and initiated onto AZT whilst awaiting the CD4 cell count result. If the result is CD4 is 350 or less the woman must commence lifelong ART within 2 weeks. If the CD4 is more than 350, then she continues on AZT.

**Unbooked women reporting in labour** should be counselled and tested for HIV during the first stage of labour and offered a PMTCT intervention as per guidelines. If this is not possible, counselling and testing should be offered after delivery. If the mother tests positive, the infant should be initiated onto NVP, the mother should be counselled on feeding options and counselled about infant testing. The mother must be staged and a CD4 cell count taken prior to discharge with a follow up visit scheduled within one week. If eligible for ART (CD4 of 350 or less or WHO stage 3 or 4) she should commence lifelong ART within 2 weeks.

Information on a patient’s HIV status, PMTCT or ART regimen, and CD4 cell count should be shared between health care personnel at all levels of the health service, while respecting the confidentiality of women and children. This is called **shared confidentiality** amongst health care workers, and is essential for maintaining continuity of care among women and infants. This entails thorough completion of the Road- to-Health Card, particularly as it relates to HIV.

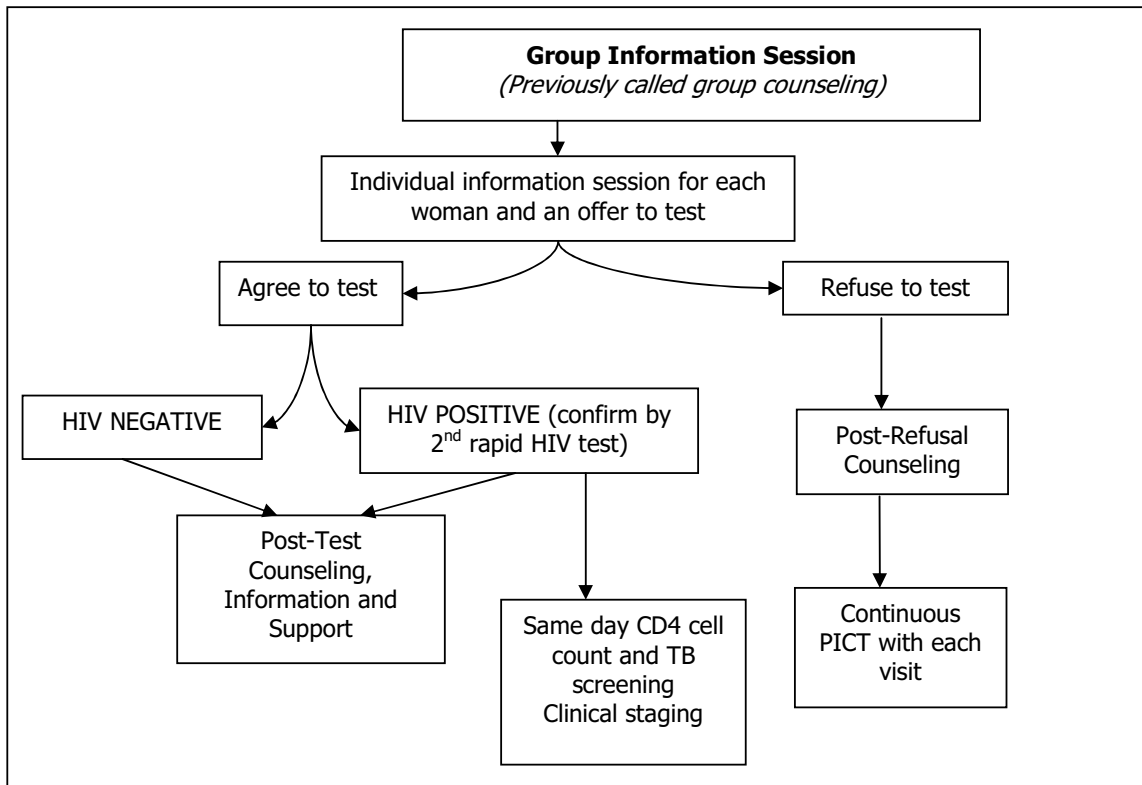


## 4. PROVIDER-INITIATED COUNSELLING AND TESTING

### 4.1 OVERVIEW

- All women attending antenatal care (both first-time attendees and women attending follow-up visits) should be given routine information about HIV testing and the PMTCT programme.
- The initial information on HIV and its transmission should be given in a '**Group Information Session**'.
- Thereafter, all women who have not previously been tested or those who require repeat testing should meet with a counsellor, nurse, or midwife for a one on one '**Individual Information Session**'.
- At the individual information session, each woman should be informed of the **routine HIV testing procedure** and should be given the opportunity to ask further questions. The woman should **then be offered** an HIV test and asked to provide verbal consent to the testing. A woman may refuse an HIV test ("opt-out").
- Women who opt-out of HIV testing should be offered post-refusal counselling to explore the reasons for this choice, address any misunderstandings, and encourage her to reconsider her decision not to test, but without applying undue pressure. These women should be offered routine HIV testing at each subsequent clinic visit.
- Information should be offered before the testing procedure and counselling should occur after the test results are provided.
- All women who test HIV positive should have their HIV status confirmed using a second rapid HIV test.
- Post-test counselling should be offered to both HIV positive and HIV negative women; HIV positive women should only be counselled after a second rapid HIV test has been performed to confirm a positive HIV status.
- The flow chart below summarises the processes involved in provider-initiated counselling and testing.

**Figure 7: Provider-initiated counselling and testing**



Details of what information should be provided during pre-test and individual information sessions are contained in the boxes below.

**PRE-TEST GROUP INFORMATION SESSION**

*Staff should conduct a general group information session on HIV and PMTCT-related issues for all women coming for first or repeat antenatal visits. A group information session should include the following key components:*

- *Benefits to the woman*
  - *Information about HIV transmission and how to prevent it as an individual and as a couple*
  - *Information about the HIV testing process*
  - *Emphasis on the importance of early access to antiretroviral therapy, for the mother's own health*
  - *Information about the high mortality due to HIV& AIDS*
  - *Information that maternal deaths are preventable, and that PMTCT is one such effort*

*Benefits to the foetus and infant:*

- *Information about mother-to-child transmission of HIV and possible measures to reduce this*
- *Information on interventions that can keep HIV-exposed infants healthy, such as cotrimoxazole prophylaxis and antiretroviral therapy*
- *Assurance on confidentiality, a discussion of shared confidentiality, and couple counselling*
- *Emphasis on the need for PCR testing at 6 weeks post-partum and its benefits*
- *Emphasis on the importance of adherence to prophylaxis or treatment*

*The group information session should provide further information on the programme, and include the fact that HIV testing is a necessary step for enrolment into the PMTCT programme, unless a woman's status is already known to be positive. Furthermore, CD4 cell count and clinical staging are important for clinical decision making.*

### ***INDIVIDUAL INFORMATION SESSION***

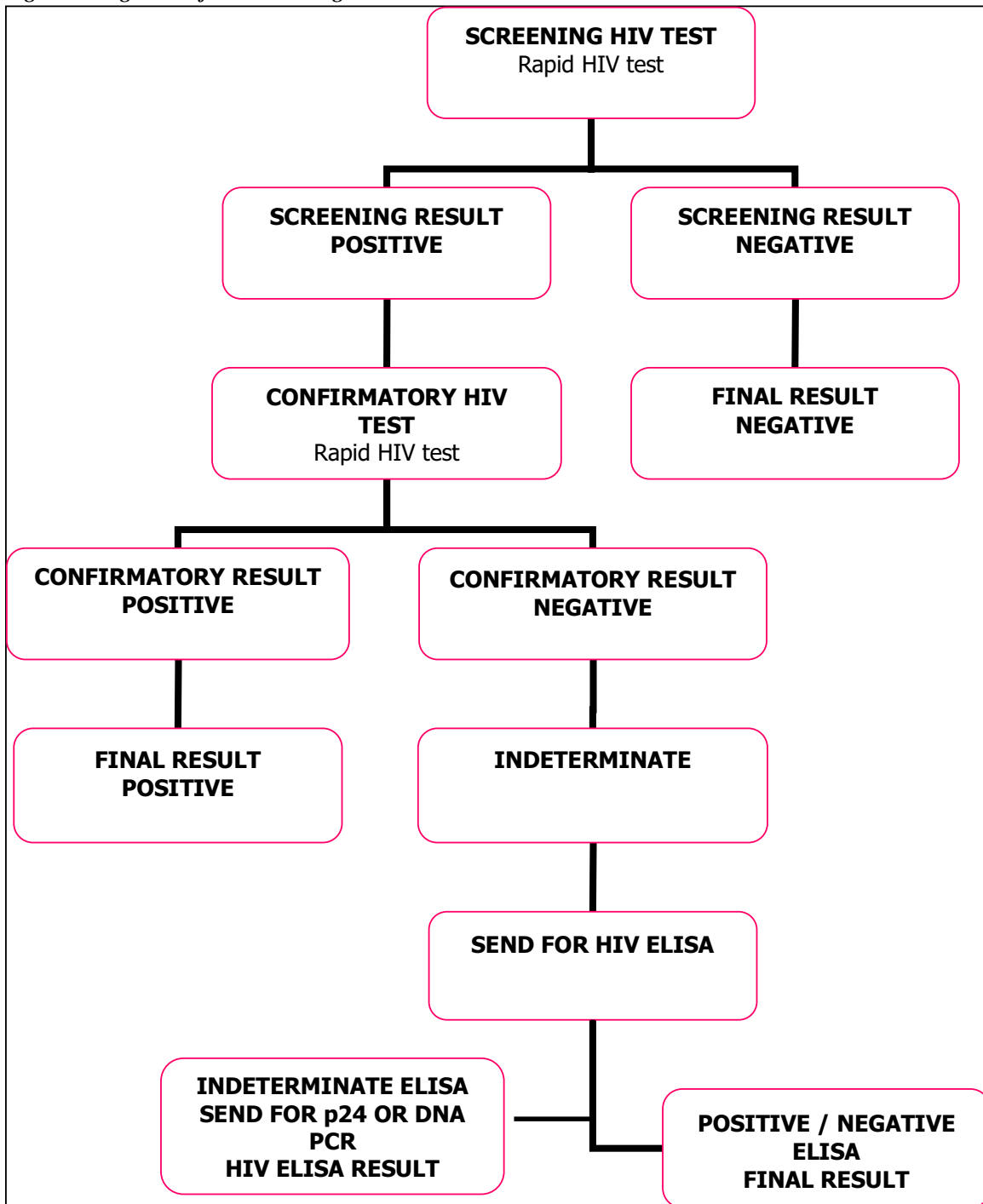
- *An individual information session should be available to all pregnant women following the group information session. This should instil a positive focus and acceptance on the client's side.*
- *The components of the individual information session include:*
  - *An assessment of whether the information provided in the group session has been understood*
  - *Answers to any remaining questions, with an aim to clarify any misunderstanding*
  - *A discussion of the way forward and the treatment options within the PMTCT intervention*
  - *Verbal consent for HIV testing*

## **4.2 TESTING ALGORITHM FOR PREGNANT WOMEN**

- Testing must be seen as a key entry point to accessing HIV care and PMTCT services.
- Ensure that the testing algorithm outlined in the HCT Policy is followed.
- HIV testing of women should occur as part of the first antenatal encounter. Enough blood should be collected for routine antenatal screenings – including haemoglobin, Rhesus factor, and syphilis tests – as well as a rapid HIV test and CD4 cell count, if required.

- At the time this routine blood sample is drawn, a **rapid HIV test** should be done using either a drop of blood from the venepuncture site or a finger prick.
- If the test is negative and the woman is asymptomatic, she is considered to be HIV negative. Women who test HIV negative should be offered a repeat HIV test from 32 weeks gestation to detect late sero-conversion or late infection.
- **If the rapid HIV test is positive**, a **second confirmatory HIV test** should be done utilizing blood from a second finger prick and another rapid HIV test kit (from a different supplier). The woman should be present when this confirmatory test is done. A client is HIV positive only if the second confirmatory rapid test is also positive.
- If the results are discordant (i.e. the first rapid HIV test is positive and the second rapid HIV test is negative), a specimen of blood should be collected and a laboratory ELISA test conducted. The woman must be asked to return for the HIV ELISA test results urgently (ideally within a week). The healthcare provider should explain the reason for the laboratory test to the client.
- For women who missed the opportunity to be tested at the first antenatal visit, the testing algorithm should be followed whenever consent is given and testing occurs.
- The CD4 cell count and TB screening should follow the HIV test and should be done at the same visit.
- Professional nursing staff and lay counsellors or community health workers (CHWs) in the facility should be trained to perform the rapid HIV tests, following specific manufacturer's instructions and quality control protocols.

Figure 8: Algorithm for HIV testing:



### 4.3 POST-TEST COUNSELLING

All HIV positive and HIV negative women should receive post-test counselling. The box below summarises the information that should be provided during post-test counselling.

#### ***POST-TEST COUNSELLING FOR ALL WOMEN REGARDLESS OF HIV STATUS***

- *Post-test counselling sessions should include information on:*
  - *HIV transmission risks*
  - *Safe sex and the availability and use of condoms*
  - *Contraception and future fertility*
  - *Treatment options*
  - *MTCT and HIV and possible interventions (ART, revised obstetric practices)*
  - *Partner testing*
  - *Safe infant feeding options for HIV positive women*
  - *Infant prophylaxis*
  - *Infant feeding counselling for HIV negative women*
  - *Stigma*
  - *Referral to support services*
  
- *All women regardless of their HIV status must receive post-test counselling. The component of post test counselling for all women should include:*
  - *One-on-one interaction with clients*
  - *Provide HIV test results as soon as possible after testing*
  - *Give the results clearly in a manner that does not instil fear or anxiety*
  - *Deal with the feelings arising from positive and negative results*
  - *Discuss prevention of infections and the "window period"*
  - *Identify and help with the woman's immediate concerns*
  - *Discuss what support the woman has and needs*
  - *Discuss with whom the client may want to share the results*
  - *Discuss the importance of partner testing*
  - *Discuss the benefits of disclosure*
  - *Identify what difficulties the client foresees and how to deal with them*
  - *Educate and encourage safer sexual practices; provide condoms*
  - *Encourage the woman to ask questions*
  - *Provide information on a healthy lifestyle, medical follow-up, and local support systems*
  - *Provide ongoing follow up and counselling*

Details of what information to discuss during post-test counselling for all women, and topics specific to HIV positive and HIV negative women, are listed in the boxes below.

- *Identify what difficulties the client foresees and how to deal with them*
- *Educate and encourage safer sexual practices; provide condoms*
- *Encourage the woman to ask questions*
- *Provide information on a healthy lifestyle, medical follow-up, and local support systems*
- *Encourage disclosure*
- *Provide ongoing follow up and counselling*

#### ***POST-TEST COUNSELLING ISSUES FOR HIV POSITIVE WOMEN***

- *All HIV-positive women should be clinically staged and have their CD4 cell count checked and be screened for TB preferably on the same day as the confirmation of their HIV-positive status.*
- *Women who have WHO clinical stage 3 or 4 disease should be initiated on lifelong ART as soon as possible.*
- *The post-test counselling session for women who are HIV positive should have the following key components covered over a number of counselling sessions, which may not occur all on the same day:*
  - *Information about antiretroviral therapy, the side effects of the medication, and where to report these*
  - *Counselling on safe infant feeding options*
  - *Counselling on exposure to stigma*
  - *Information and counselling on contraception and future family planning*
  - *Information about safer sexual practices during pregnancy and in the long-term*
  - *Information on and referral to support services and positive living*
  - *Information on disclosure*
- *HIV positive women should be offered counselling at every subsequent antenatal care visit, or earlier if the woman or counsellor deems this necessary to assist her with coping and thinking through the consequences of her diagnosis. Women should be encouraged to join a support group. Women requiring additional support should be referred to a social worker or psychologist. If counsellors identify complex issues that they are unable to handle, they should refer the client to a social worker or psychologist.*

### ***POST-TEST COUNSELLING FOR HIV NEGATIVE WOMEN***

- *HIV negative women should be offered routine antenatal services, as stipulated in the DOH Guidelines for Maternity Care in South Africa. A repeat HIV test is done from 32 weeks gestation.*
- *HIV-negative women should be counselled on:*
  - *Prevention and risk reduction behaviour (the risk of transmission from mother to child is particularly high for women infected with HIV during pregnancy)*
  - *Safe sexual practices*
  - *The high risk of transmission of HIV to her infant, if newly infected during pregnancy or breastfeeding*
  - *The benefits of exclusive breastfeeding for the first 6 months and continued breastfeeding thereafter and introduction of complementary foods.*



## **5. ROUTINE CLINICAL CARE FOR HIV-POSITIVE PREGNANT WOMEN**

HIV positive pregnant women require all components of routine antenatal care. These include: iron and folate supplementation; the provision of antiretroviral drugs for prophylaxis and treatment; the prevention and management of opportunistic infections; the modification of obstetric practices, especially during labour and delivery; integrating HIV management, especially 3-hourly AZT into the partogram as part of labour management; counselling on infant feeding options; and counselling on safer sex, family planning, and contraception.

### **5.1 ANTENATAL MANAGEMENT**

#### **INITIAL ASSESSMENT**

At their first antenatal clinic visit all HIV positive women should have the following, in addition to routine antenatal procedures:

1. CD4 cell count
2. HIV clinical staging
3. Clinical screening for TB and STIs
4. Alamine Aminotransferase
5. Initiation of antiretroviral prophylaxis or treatment

#### *CD4 CELL COUNT*

- The follow-up date must be one week after the CD4 cell count has been taken to ensure prompt initiation of lifelong ART if eligible.
- Laboratory turnaround times for CD4 cell counts should be under one week.
- Women who do not return for CD4 cell count results should be actively traced and advised to return for their results.

#### *HIV CLINICAL STAGING*

Clinical assessment and staging of all HIV-positive women should be conducted at their first antenatal visit.

#### *CLINICAL SCREENING FOR TUBERCULOSIS*

Co-infection with TB and HIV is common. If an HIV positive patient has symptoms suggestive of TB, two sputum specimens should be collected for smear microscopy and a TB culture. It is very important to investigate patients for tuberculosis before starting ART.

The healthcare provider should suspect TB if two or more of the following are present:

1. Cough >2 weeks
2. Sputum production, which may occasionally be blood stained
3. Fever >2 weeks
4. Drenching night sweats >2 weeks
5. Unexplained weight loss ( $\geq 1.5$  kg over the past 4 weeks or poor weight gain during pregnancy)
6. Loss of appetite, malaise, or tiredness
7. Shortness of breath or chest pains

### *ALT*

A baseline ALT to measure liver function should be done before administering NVP.

### *INITIATION OF ANTIRETROVIRAL THERAPY*

It is important to avoid unnecessary delays in initiating lifelong ART. Pregnant women should be staged to determine indication for ARV treatment or prophylaxis, according to WHO clinical staging and CD4 cell count. The following eligibility criteria apply for pregnant mothers:

**Women with a CD4 cell count of more than 350 cells/ mm<sup>3</sup> and WHO stage 1 and 2 disease** should receive antiretroviral prophylaxis with AZT to reduce mother-to-child transmission.

**Women with a CD4 cell count of  $\leq 350$  cells/ mm<sup>3</sup> or less WHO clinical stage 3 or 4** should receive lifelong antiretroviral treatment, both for their own health and to reduce the likelihood of mother-to-child transmission.

### **ANTIRETROVIRAL PROPHYLAXIS**

HIV positive pregnant women who are not eligible for lifelong ART are given a PMTCT regimen for prophylaxis to reduce mother-to-child transmission. The regimen includes antenatal, intrapartum, and postnatal components. The maternal PMTCT regimen is: **Antenatal** Zidovudine (AZT) from 14 weeks; **Intrapartum** single-dose Nevirapine (sdNVP), 3 hourly AZT, and a **Postpartum** single dose of Tenofovir (TDF) + Emtricitabine (FTC)

Antenatal AZT should be initiated from 14 weeks gestation or as soon as possible thereafter, unless laboratory findings indicate that the mother is severely anaemic (i.e. Hb<8g/dl) or if the woman is clinically pale. Iron and folate supplementation should be provided to all antenatal women routinely. Women should return monthly for AZT.

### **LIFELONG ANTIRETROVIRAL TREATMENT**

HIV positive pregnant women eligible for lifelong ART should start lifelong ART as early as possible and continue throughout pregnancy, delivery, and for the rest of their lives. Lifelong ART

benefits maternal health and contributes to maternal survival and reduces mother-to-child transmission.

Initiation of ART is recommended for all HIV positive pregnant women with CD4 cell count of 350 or less, irrespective of WHO clinical staging, and for all HIV-positive pregnant women in WHO clinical stage 3 or 4, regardless of CD4 cell count and women co-infected with TB/HIV.

Pregnant women initiated on lifelong ART should be seen two weeks after ART initiation and then monthly. Monitoring for treatment failure and toxicity should follow the recommendations in the adult ART guidelines.

**Women on lifelong ART who become pregnant** continue with treatment as per adult ARV guidelines (including those on second line regimens). In cases in which a woman is taking an EFV-containing regimen, EFV should be substituted with NVP only if she is still in the first trimester.

**Women who initially test negative and subsequently test positive during pregnancy** should be initiated onto AZT immediately. A CD4 cell count should be taken, clinical staging and TB screening done, and lifelong ART commenced if eligible. If CD4 is 350 or more then the mother should continue with AZT.

#### **SPECIAL CIRCUMSTANCES:**

##### *TUBERCULOSIS INFECTION*

Tuberculosis is a stage WHO 3 disease and as such, TB-infected pregnant women, regardless of CD4 cell count, qualify for ART. TB treatment should be prioritised prior to initiating lifelong ART.

- **If CD4 > 250 cells/mm<sup>3</sup>:** Start ART only after patient has stabilised on TB treatment (2-8 weeks after starting treatment) and initiate ART from 12 weeks gestation onwards
- **If CD4 < 250 cells/mm<sup>3</sup>:** Start ART only after patient has stabilised on TB treatment (2-8 weeks after starting treatment).
- **If severe morbidity or very low CD4 count (< 50 cells/mm<sup>3</sup>):** Start ART after 2 weeks of TB treatment
- **Pregnant women who develop TB while on lifelong ART** should continue their existing ART regimen, unless they are taking LPV/r. In this case, the LPV/r dose should be doubled

##### *HEPATITIS B INFECTION*

Two antiretroviral agents with activity against hepatitis B should be used to control both HIV and hepatitis B. TDF and 3TC/FTC have activity against hepatitis B, and it is recommended that TDF should substitute for D4T in these co-infected patients.

## **5.2 INTRAPARTUM MANAGEMENT**

The woman's serostatus should be recorded in the maternity register. Health care workers should check the woman's documented HIV status and details of the antiretroviral drugs received during pregnancy. If her HIV status is unknown and she is in the first stage of labour, HIV testing and counselling should be provided. If this is not possible prior to delivery, then HIV testing and counselling should be provided as soon as possible after delivery.

### **ANTIRETROVIRAL PROPHYLAXIS**

HIV-positive women who are not on lifelong ART should receive AZT 3-hourly and sdNVP. Single dose TDF+FTC should be given post delivery.

### **ANTIRETROVIRAL TREATMENT**

Women who are on lifelong ART should continue their regimen throughout labour and delivery. They do not require **additional** intrapartum sdNVP or 3hourly AZT or postpartum TDF and FTC.

### **INTRAPARTUM SPECIAL CIRCUMSTANCES**

Caesarean sections should be performed for obstetric indications and are not recommended to reduce mother-to-child transmission. For planned (elective) Caesarean sections, antiretroviral prophylaxis (sdNVP + TDF + FTC) should ideally be given four hours prior to the procedure. Women who are on lifelong ART should continue their standard ART regimen. In the case of an emergency Caesarean section, ensure that the woman receives sdNVP + TDF + FTC prophylaxis prior to the procedure.

All HIV-positive women who undergo Caesarean sections should receive prophylactic antibiotics.

## **5.3 SAFE DELIVERY TECHNIQUES**

MTCT risk is increased by prolonged rupture of membranes, assisted instrumental delivery, invasive monitoring procedures, episiotomy, and prematurity. Only suction the baby's nose and airway when there is meconium-stained liquor.

## **5.4 POSTNATAL CARE**

### **CARE OF HIV-POSITIVE WOMEN AND THEIR INFANTS IN THE IMMEDIATE POST-DELIVERY PERIOD**

- Within an hour of delivery:
  - Infants born to HIV-positive women should receive skin-to-skin contact with their mothers, regardless of the mother's infant feeding choice.

- All infants should start feeding (exclusive breastfeeding on demand or exclusive formula feeding). Initiate HIV-exposed infants on NVP prophylaxis immediately after birth
- If the mother has not made a decision about feeding yet, she should be counselled on infant feeding.
- All women, whether on ART or not, and their infants should receive follow-up at the health facility within the first 3 days postpartum, and should be seen again at the health facility prior to 6 weeks postpartum. Thereafter, follow-up should occur at the well-infant clinics, as per the IMCI guidelines.
- Infant testing should be done at 6 weeks (see section on infant testing). Contraception should be discussed and offered to all women after delivery and at subsequent visits
- Ongoing psychosocial support should address the following:
  - Infant feeding choice and practice
  - Social security issues
  - Child health
  - Positive prevention for HIV & AIDS

## **ANTIRETROVIRAL PROPHYLAXIS**

There is high morbidity and mortality of HIV positive women in the postpartum period. Therefore, women who are not on ART should be assessed for lifelong ART eligibility by doing a CD4 count test. If the woman is found to be eligible she should commence lifelong ART within 2 weeks. Support for women initiated on lifelong ART during pregnancy is particularly important in the postnatal period. Appropriate referral for ongoing care must be ensured.

## **INFANT PROPHYLAXIS**

Antiretroviral prophylaxis given soon after birth to all HIV-exposed infants is effective in reducing mother-to-child transmission whether maternal ARVs are received or not, and forms the basis of a post-exposure prophylaxis strategy. Infant antiretroviral prophylaxis is also highly effective in reducing transmission through breast milk.

Ideally, all infants born to HIV-positive women should receive skin-to-skin contact with their mothers, regardless of the mother's feeding choice.

Infants born to HIV-positive women should receive daily nevirapine for 6 weeks, with dosing determined as follows:

- **If birth weight  $\geq$  2.5kg: 15mg**
- **If birth weight  $<$  2.5kg: 10mg**
- **Infant prophylaxis should be initiated as soon as possible after delivery.**

**ABANDONED INFANTS** should receive NVP as soon as possible (<72 hours) after birth and continued until HIV-exposure status has been determined, using a rapid test or an HIV ELISA test. If the infant has been HIV-exposed, NVP should continue until 6 weeks of age and followed by a PCR at 6 weeks.

**IF MATERNAL STATUS IS UNKNOWN**, including cases in which the mother is indisposed (due to severe illness, coma, mental illness, or death), the infants should receive NVP and have an HIV test (ELISA or e rapid test) to inform further management of the infant.

**WHERE THE MOTHER IS KNOWN TO BE HIV-POSITIVE, BUT SHE REFUSES ANY ARV PROPHYLAXIS FOR THE INFANT**, a counsellor must intervene to explain the risks of mother-to-child transmission and the benefits of antiretroviral therapy. Should this counselling fail to convince the mother to adopt infant prophylaxis, the mother should then be informed of the infant's right to receive protection from acquiring HIV. The healthcare worker should consult the head of the facility and, with his or her permission, provide the necessary treatment in the best interest of the infant. In all actions concerning children, the best interests of the child shall be a primary consideration (Children's Act, No 38 of 2005).

## 6. REGIMENS

**Table 1: Standardised national ART and ARV regimens for women who are HIV positive and pregnant and their infants**

Maternal regimens		
Woman	Regimen	Comment
<b>Eligible for lifelong ART</b> (i.e. CD4 $\leq$ 350 or WHO clinical stage 3 or 4)	TDF + 3TC/FTC + NVP	Start lifelong ART within 2 weeks
<b>Currently on lifelong ART</b>	Continue ART	Substitute EFV with NVP if in first 12 weeks of pregnancy
Contraindication to TDF (renal disease)	AZT+ 3TC + NVP	
<b>Not eligible for ART</b> i.e. CD4 > 350 and WHO stage 1 or 2	AZT from 14 weeks sdNVP + AZT 3hrly in labour TDF + FTC single dose (stat) after delivery	
<b>Unbooked and presents in labour</b>	sdNVP + AZT 3hrly in labour TDF + FTC single dose after delivery	Assess maternal ART eligibility before discharge

**Table 2: Infant Regimens**

Infant regimens		
Infant	Regimen	Comment
Mother on lifelong ART	NVP at birth and then daily for 6 weeks irrespective of infant feeding choice	
Mother on PMTCT regimen	NVP at birth and then daily for 6 weeks continued as long as <b>any</b> breastfeeding	If formula fed baby can stop NVP at 6 weeks
Mother did not get any ARV before or during delivery	NVP as soon as possible and daily for at least 6 weeks continued as long as <b>any</b> breastfeeding	Assess ART eligibility for the mother within 2 weeks
Unknown maternal status because orphaned or abandoned	Give NVP immediately* Test infant with rapid HIV test. If positive continue NVP for 6 weeks. If negative discontinue NVP	Follow up 6 week HIV DNA PCR

\* If rapid HIV test can be done within 2 hours, then wait for HIV result before commencing NVP

**Table 3: ARV Adult Dosing Guide**

<b>Drug</b>	<b>Dosage</b>	<b>Notes</b>
TDF (Tenofovir)	300mg daily	Tenofovir is contraindicated in creatinine clearance of <50ml/min
d4T (Stavudine)	30mg 12hrly po	All adult patients now receive 30mg regardless of weight
3TC (Lamivudine)	150mg 12 hourly po OR 300mg daily	
FTC (Emtracitabine)	200mg daily	
NVP (Nevirapine)	200mg dly po X 2 weeks then 200mg 12 hourly po  For PMTCT purposes single dose (sdNVP) is used as a 200mg tablet given once.	Should be used with caution with TB treatment
EFV (Efavirenz)	600mg nocte	Avoid in first trimester of pregnancy and psychiatric conditions
Kaletra® (lopinavir 133.3mg /ritonavir 33.3mg)	3 tabs 12 hourly  (Lop400mg/Rit100mg)	Preferably taken with food. Boosting required with TB treatment Store in a cool place
Aluvia® (lopinavir 200mg /ritonavir 50mg)	2 tabs 12 hourly  (Lop400mg/Rit100mg)	Preferably taken with food. Boosting required with TB treatment
AZT (Zidovudine)	300mg 12 hourly po	Avoid if severe anaemia (Hb <8g/dl)

*\*Doses and frequency will remain the same when used intrapartum*

**Table 4: NVP Infant Dosing Guide**

<b>Drug</b>	<b>Birth Weight</b>	<b>Dose</b>	<b>Quantity</b>
NVP syrup (10mg/ml)	<u>Birth to 6 weeks</u> ≤2.5kg birth weight	10mg/d	1ml
	<u>Birth to 6 weeks</u> ≥ 2.5kg birth weight	15mg/d	1.5ml
	For all: 6 weeks to 6 months	20mg/d	2ml
	6 months to 9 months	30mg/d	3ml
	9 months to end BF	40mg/d	4ml



## **7. ESTABLISHING SAFE INFANT FEEDING PRACTICES**

### **7.1 BACKGROUND**

- The South African national PMTCT programme adopts an approach to infant feeding that maximizes child survival, not only the avoidance of HIV transmission.
- The South African Infant and Young Child Feeding Policy, its implementation guidelines, and the Baby Friendly Hospital Initiative (BFHI) – in particular, the ten steps to safe infant feeding outlined in the BFHI – should be followed to facilitate feeding support for HIV-positive and HIV-negative women.
- All mothers who are known to be HIV-infected either on lifelong ART or not, who exclusively breastfeed their infants should do so for 6 months, introduce appropriate complementary foods thereafter, and continue breastfeeding for the first 12 months of life.
- Mothers who are known to be HIV-infected, and not on lifelong ART, who decide to stop breastfeeding at any time should do so gradually during one month whilst the baby continues to receive daily NVP and should continue for one week after all breastfeeding has stopped.

### **PRINCIPLES OF SAFE INFANT FEEDING**

- Health care personnel, lay counsellors, and community caregivers should receive standardized training on infant feeding, counselling, and HIV.
- Trained health care personnel should provide high quality, unambiguous, and unbiased information about risks of HIV transmission through breastfeeding, ART prophylaxis to reduce this risk, and risks of replacement feeding.
- Counselling on infant feeding must commence after the first post-test counselling session in pregnancy.
- Infant feeding should be discussed with women at every antenatal visit.
- Mixed feeding during the 1<sup>st</sup> 6 months of life should be strongly discouraged as it increases the risk of childhood infections.
- Mass mobilization and communication on infant feeding and HIV should be done through mass media, including distribution of information education communication (IEC) materials and community-based activities.
- In an attempt to optimise child survival, HIV-positive pregnant women should be fast-tracked for lifelong ART or PMTCT regimens in order to keep them healthy and reduce MTCT.

### **HIV-negative women**

- At every antenatal visit, HIV-negative women or women of unknown HIV status should be advised to exclusively breastfeed their babies during the first 6 months of life and continue breastfeeding for at least 2 years. Every effort should be made to have all pregnant women

HIV tested and retested as outlined in the testing section of this document.

### **HIV-positive women**

- At every antenatal visit, HIV-positive women should be counselled on safe infant feeding.
- Each pregnant HIV-positive woman should receive at least four antenatal counselling sessions on infant feeding and ARV prophylaxis.

### **Postnatal support for infant feeding**

- During the postnatal period, mother-infant pairs should have a follow-up visit within 3 days after delivery to review feeding practices, check breast health, maternal health and child health, and provide general support.
- All HIV-positive infants should continue breastfeeding for at least 2 years.

### **Formula feeding HIV-positive women:**

- Free commercial infant formula will be provided to infants for at least 6 months.
- Women should receive practical support, including demonstrations on how to safely prepare formula and feed the infant.
- At 6 months of age, infants with or at risk of poor growth should be referred for continued nutritional monitoring and dietary assistance.
- An appropriate formula milk product for the infant's age and circumstances should be chosen.
- Infants weighing <2 kg should receive a special low birth weight formula until the infant weighs at least 2 kg; thereafter infant formula for a term infant can be given. A soy protein based formula should not be given to an infant <2kg.
- All health care workers caring for mothers, infants, and young children should fully adhere with all the provisions of the **International Code of Marketing of Breast Milk Substitutes** and its subsequent resolutions, which will be superseded by the South African Regulations relating to Foodstuffs for Infants, Young Children, and Children once they are promulgated. These regulations have been adapted to allow for infant feeding in the context of HIV.
- In cases in which commercial formula is provided free of charge at health facilities, managers, supervisors, and health care personnel should ensure an uninterrupted supply at clinic level. A reliable procurement and distribution system should be put in place.

***For mothers who have chosen to avoid all breastfeeding:***

- *Formula feeding mothers require support at every well child / routine visit, every immunization visit, and every sick child visit to facilitate and support exclusive formula feeding.*
- *Formula milk preparation should be demonstrated at the first postnatal visit and as needed thereafter, and discussed at every visit.*
- *Health care personnel should:*
  - *Provide clear guidance regarding the volume and frequency of feeding needed at each age.*
  - *Discuss the dangers associated with bottle-feeding and how bottles should be cared for, if used. Discuss and demonstrate cup feeding as a recommended alternative to bottle-feeding.*
  - *Discuss home support for avoiding breastfeeding – ensure that the woman has a supporter outside the health facility to help her avoid all breastfeeding.*

## 8. INFANT FOLLOW-UP

Prior to discharge, notes should be written on the 'Road-to-Health' chart to indicate whether the infant has received ARVs and what feeding choice the mother has made. This will optimise infant prophylaxis, improve the infant's access to appropriate care, and reduce morbidity and mortality.

Infants should receive follow-up visits according to the IMCI clinical case management guidelines, including:

- Weekly visits during the first month of life
- Monthly visits thereafter, until the age of twelve months
- Three-monthly visits between the age of 12 months and two years of age unless the child is ill; in this case they should be seen more often

During the first post-delivery visit:

- All HIV-exposed infants should receive NVP daily for 6 weeks. If the infant is formula fed, the health care worker should check the method of cleaning utensils and preparing formula. Formula preparation should be demonstrated after counselling when women have chosen not to breastfeed. Demonstration (to ensure safe and correct preparation) is essential for HIV-positive women.
- If the infant is breastfed, the pattern of feeding, attachment, and positioning and the mother's breast health must be checked.

HIV-exposed infants should be tested for HIV at 6 weeks of age, or before 6 weeks of age if they are sick (see section on HIV testing).

NVP to be stopped at 6 weeks in infants:

- Who are formula fed,
- Whose mothers are on lifelong ART
- Who are diagnosed as HIV infected.

ALL HIV-exposed infants commence CTX prophylaxis at 6 weeks of age.

All infants identified as being HIV positive should have a confirmatory viral load and be referred for urgent ART initiation.

Early ART should be initiated in all HIV positive infants.

HIV-exposed infants should be followed up AT LEAST monthly in the first year of life and every three months thereafter, regardless of their method of feeding. Infants clinically suspected of having HIV should be tested for HIV, regardless of their age.

At 6, 10, and 14 weeks, and at 9 and 18 months, all children should be immunized according to the South African EPI schedule.

All HIV-exposed infants not on ART should have a rapid HIV test at 18 months of age.

#### ***ROUTINE FOLLOW-UP OF HIV-EXPOSED INFANTS***

***At each visit, perform the following:***

- *Monitor growth*
- *Monitor developmental Milestones*
- *Check history of current illnesses*
- *Check immunization status*
- *Conduct a clinical examination where indicated, and refer to a higher level of care if needed*
- *Assess feeding difficulties and discuss ways of overcoming them*
- *Assess feeding pattern*
- *Provide free commercial formula milk to formula-fed infants on a monthly basis until six months postpartum*
- *Provide nutritional support for ALL breastfeeding HIV-positive mothers and for formula feeding mothers with food insecurity*
- *Provide NVP for breast-fed infants whose mothers are not on lifelong ART, until one month after breast feeding cessation.*
- *Continue CTX in breastfed infants until cessation of breast feeding and confirmed HIV negative.*

## 9. REFERENCES

1. Manosuthi, W., et al., *Incidence and risk factors of nevirapine-associated severe hepatitis among HIV-infected patients with CD4 cell counts less than 250 cells/microL*. J Med Assoc Thai, 2008. **91**(2): p. 159-65.
2. Torti, C., et al., *Analysis of severe hepatic events associated with nevirapine-containing regimens: CD4+ T-cell count and gender in hepatitis C seropositive and seronegative patients*. Drug Saf, 2007. **30**(12): p. 1161-9.
3. Cadman, J., *Efavirenz pregnancy warning*. GMHC Treat Issues, 1998. **12**(3): p. 12.
4. Bussmann, H., et al., *Pregnancy rates and birth outcomes among women on efavirenz-containing highly active antiretroviral therapy in Botswana*. J Acquir Immune Defic Syndr, 2007. **45**(3): p. 269-73.
5. WHO. *Antiretroviral drugs for treating pregnant women and preventing HIV infection in infants in resource-limited settings: towards universal access*. 2006 [cited 2007 5 September]; Available from: <http://www.who.int/hiv/pub/guidelines/pmtct/en/index.html>.
6. *Mother-to-child transmission of HIV infection in the era of highly active antiretroviral therapy*. Clin Infect Dis, 2005. **40**(3): p. 458-65.
7. Cooper, E.R., et al., *Combination antiretroviral strategies for the treatment of pregnant HIV-1-infected women and prevention of perinatal HIV-1 transmission*. J Acquir Immune Defic Syndr, 2002. **29**(5): p. 484-94.
8. Read, J.S., et al., *Management of human immunodeficiency virus-infected pregnant women at Latin American and Caribbean sites*. Obstet Gynecol, 2007. **109**(6): p. 1358-67.
9. van der Merwe, K., et al., *Integration of Antiretroviral Treatment Within Antenatal Care in Gauteng Province, South Africa*. J Acquir Immune Defic Syndr, 2006. **43**(5): p. 577-581.
10. Hoffman R., B.V., Technau K., van der Merwe K., Currier J., Coovadia A and Chersich M, *Effects of Highly Active Antiretroviral Therapy Duration and Regimen on Risk for Mother-to-Child Transmission of HIV in Johannesburg, South Africa*. JAIDS, 2010.
11. Marazzi MC, N.-S.K., Buonomo E, Scarcella P, Germano P, Majid NA, Zimba I, Ceffa S, Palombi L, *Increased infant human immunodeficiency virus-type one free survival at one year of age in sub-saharan Africa with maternal use of highly active antiretroviral therapy during breast-feeding*. Pediatr Infect Dis J, 2009. **28**: p. 483-7.
12. Marazzi MC, L.G., IAS Cape Town, 2009.
13. Ahoua L, A.H., Gnauck K, Odaru G, Odar E, Ondoa-Onama C, Pinoges L, Balkan S, Olson D, Pujades-Rodríguez M, *Evaluation of a 5-year Programme to Prevent Mother-to-child Transmission of HIV Infection in Northern Uganda*. J Trop Pediatr, 2009. **E pub ahead of print**.
14. Dabis, F., et al., *Field efficacy of zidovudine, lamivudine and single-dose nevirapine to prevent peripartum HIV transmission*. Aids, 2005. **19**(3): p. 309-18.
15. Lallemand, M., et al., *Single-dose perinatal nevirapine plus standard zidovudine to prevent mother-to-child transmission of HIV-1 in Thailand*. N Engl J Med, 2004. **351**(3): p. 217-28.

16. Briand, N., et al., *Haematological safety of perinatal zidovudine in pregnant HIV-1-infected women in Thailand: secondary analysis of a randomized trial*. PLoS Clin Trials, 2007. **2**(4): p. e11.
17. Sinha G, C.T., Nayak U, Gupta A, Nair S, Gupte N, *Clinically significant anemia in HIV-infected pregnant women in India is not a major barrier to zidovudine use for prevention of maternal-to-child transmission*. J Acquir Immune Defic Syndr, 2007. **45**: p. 210-7.
18. Leroy, V., et al., *Is there a difference in the efficacy of peripartum antiretroviral regimens in reducing mother-to-child transmission of HIV in Africa?* Aids, 2005. **19**(16): p. 1865-1875.
19. Nakabiito C, et al. *Effect of nevirapine (NVP) for perinatal HIV prevention appears strong among women with advanced disease: subgroup analyses of HIVNET 012*. in *XIV International AIDS Conference*. 2002 Barcelona.
20. Leroy, V., et al., *Twenty-four month efficacy of a maternal short-course zidovudine regimen to prevent mother-to-child transmission of HIV-1 in West Africa*. AIDS, 2002. **16**(4): p. 631-41.
21. Kuhn L, R.C., Abrams CJ, *Breast feeding and AIDS in the developing* Curr OpinPediatr, 2009. **21**: p. 83-90.
22. Gaillard, P., et al., *Use of antiretroviral drugs to prevent HIV-1 transmission through breast-feeding: from animal studies to randomized clinical trials*. J Acquir Immune Defic Syndr, 2004. **35**(2): p. 178-87.
23. Mofenson, L., *Prevention of breast milk transmission of HIV: the time is now*. JAIDS, 2009. **52**: p. 305-308.
24. Black V., O.R., Rees H, *Chersich M.W. High HIV Incidence or Poor Test Performance?* AIDS. **23**: p. 2234-5.
25. Moodley D, E.T., Pather T, Chetty V, Ngaleka L, *High HIV incidence during pregnancy: compelling reason for repeat HIV testing*. AIDS, 2009. **23**: p. 1255-1259.
26. Moodley D, M.P., Ndabandaba T, Esterhuizen T, *Reliability of HIV rapid tests is user dependent*. S Afr Med J 2008. **8**: p. 707-9.
27. Rollins N, L.K., Mzolo S, Horwood C, Newell ML., *Surveillance of mother-to-child transmission prevention programmes at immunization clinics: the case for universal screening*. AIDS, 2007. **19**(21(10)): p. 1341-7.
28. Lu L et al, M., *HIV incidence in pregnancy and the first post-partum year and implications for PMTCT programs, Francistown, Botswana*. Sixteenth Conference on Retroviruses and Opportunistic Infections, 2009. **abstract 91**.
29. Black V, Y.J., Moultrie H, Waldman K, O'Brien M, *Modeling changes to South Africa's PMTCT programme*. IAS Cape Town, 2009.
30. (CDC)., C.f.D.C.a.P., *Acute HIV Infection --- New York City, 2008*. MMWR Morb Mortal Wkly Rep, 2009. **58**: p. 1296-9.
31. Hecht, F.M., et al., *A multicenter observational study of the potential benefits of initiating combination antiretroviral therapy during acute HIV infection*. J Infect Dis, 2006. **194**(6): p. 725-33.
32. Liang, K., et al., *A case series of 104 women infected with HIV-1 via blood transfusion postnatally: high rate of HIV-1 transmission to infants through breast-feeding*. J Infect Dis, 2009. **200**(5): p. 682-6.

33. Phillips, A., *Short-term risk of AIDS according to current CD4 cell count and viral load in antiretroviral drug-naïve individuals and those treated in the monotherapy era.* *Aids*, 2004. **18**(1): p. 51-8.
34. Jourdain, G., et al., *Intrapartum exposure to nevirapine and subsequent maternal responses to nevirapine-based antiretroviral therapy.* *N Engl J Med*, 2004. **351**(3): p. 229-40.
35. Egger, M., et al., *Prognosis of HIV-1-infected patients starting highly active antiretroviral therapy: a collaborative analysis of prospective studies.* *Lancet*, 2002. **360**(9327): p. 119-29.
36. May, M., et al., *Prognosis of HIV-1-infected patients up to 5 years after initiation of HAART: collaborative analysis of prospective studies.* *Aids*, 2007. **21**(9): p. 1185-97.
37. Bedikou, G., et al. *6-month immunological response with HAART-containing nevirapine in HIV positive women post-exposure to single-dose of nevirapine for PMTCT.* in *3rd IAS Conference on HIV pathogenesis and treatment.* 2005. Rio de Janeiro, Brazil.
38. Coovadia, A., et al. *Virologic response to NNRTI treatment among women who took single-dose nevirapine 18 to 36 months earlier.* in *13th conference on retroviruses and opportunistic infections.* 2006. Denver, Colorado, USA.
39. Lockman, S., et al. *Maternal and infant response to nevirapine-based antiretroviral treatment following peripartum single-dose nevirapine or placebo.* . in *43rd Annual Meeting of the Infectious Disease Society of America.* 2005 San Francisco, California, USA.
40. McIntyre, J., et al. *Addition of short course Combivir (CBV) to single dose Viramune (sdNVP) for the prevention of mother to child transmission (pMTCT) of HIV-1 can significantly decrease the subsequent development of maternal and paediatric NNRTI-resistant virus.* in *The 3rd IAS Conference on HIV Pathogenesis and Treatment.* 2005. Rio de Janeiro, Brazil.
41. Lockman S, C.T., *Acute maternal HIV infection during pregnancy and breast-feeding: substantial risk to infants.* *J Infect Dis*, 2009. **200**: p. 667-9.
42. McIntyre JA, H.M., Moodley D, Eklund M, Gray GE, Hall DB, Robinson P, Mayers D, Martinson NA, *Efficacy of short-course AZT plus 3TC to reduce nevirapine resistance in the prevention of mother-to-child HIV transmission: a randomized clinical trial.* *Plos Med*, 2009. **Electronic publication.**
43. Gray, G.E., et al., *A randomized trial of two postexposure prophylaxis regimens to reduce mother-to-child HIV-1 transmission in infants of untreated mothers.* *Aids*, 2005. **19**(12): p. 1289-97.
44. Taha, T.E., et al., *Nevirapine and zidovudine at birth to reduce perinatal transmission of HIV in an African setting: a randomized controlled trial.* *Jama*, 2004. **292**(2): p. 202-9.
45. Six Week Extended-Dose Nevirapine (SWEN) Study Team, e.a., *Extended-dose nevirapine to 6 weeks of age for infants to prevent HIV transmission via breastfeeding in Ethiopia, India, and Uganda: an analysis of three randomised controlled trials.* *Lancet.*, 2008. **372**: p. 300–313.
46. Kumwenda NI, H.D., Mofenson LM, et al, *Extended antiretroviral prophylaxis to reduce breast-milk HIV-1 transmission.* *N Engl J Med.*, 2008. **359**: p. 119-129.



47. Shapiro R, H.M., Ogwu A, et al. T, *he Mma Bana Study: randomized trial comparing highly active antiretroviral therapy regimens for virologic efficacy and the prevention of mother-to-child HIV transmission among breastfeeding Women in Botswana* 5th International AIDS Society Conference on HIV Pathogenesis, Treatment, and Prevention; 2009; Capetown, South Africa, 2009.
48. De Vincenzi I, K.B.S.G., *Triple-antiretroviral prophylaxis during pregnancy and breastfeeding compared to short-ARV prophylaxis to prevent mother-to-child transmission of HIV-1: the Kesho Bora randomized controlled clinical trial in five sites in Burkina Faso, Kenya and South Africa.* 5th International AIDS Society Conference on HIV Pathogenesis, Treatment, and Prevention, Cape Town, 2009.
49. Palombi L, M.M., Voetberg A, et al, *Treatment acceleration program and the experience of the DREAM program in prevention of mother to child transmission of HIV.* AIDS, 2007. **21(Suppl 4)**: p. S65-71.
50. Kilewo C, K.K., Ngarina M, Massawe A, Lyamuya E, Swai A, Lipyoga R, Mhalu F, Biberfeld G; Mitra Plus Study Team, *Prevention of mother-to-child transmission of HIV-1 through breastfeeding by treating mothers with triple antiretroviral therapy in Dar es Salaam, Tanzania: the Mitra Plus study.* J Acquir Immune Defic Syndr, 2009. **52**: p. 406-16.
51. Dunn, D.T., et al., *Risk of human immunodeficiency virus type 1 transmission through breastfeeding.* Lancet, 1992. **340**(8819): p. 585-8.
52. Breastfeeding and HIV International Transmission Study Group, et al., *Late postnatal transmission of HIV-1 in breast-fed children: an individual patient data meta-analysis.* J Infect Dis, 2004. **189**(12): p. 2154-66.
53. Miotti, P.G., et al., *HIV transmission through breastfeeding: a study in Malawi.* Jama, 1999. **282**(8): p. 744-9.
54. Arifeen, S., et al., *Exclusive breastfeeding reduces acute respiratory infection and diarrhoea deaths among infants in Dhaka slums.* . Pediatrics, 2001. **108**: p. E67.
55. Popkin, B., et al., *Breastfeeding and diarrhoeal morbidity.* . Pediatrics, 1990. **86**(6): p. 874-882.
56. Victora, C., et al., *Infant feeding and deaths due to diarrhea: a case-control study.* 1032–41. American Journal of Epidemiology, 1989. **129**: p. 1032-41.
57. Victora CG, S.P., Vaughan JP et al. , *Evidence for protection by breastfeeding against infant death from infectious diseases in Brazil.* Lancet, 1987: p. 319.
58. WHO Collaborative Study Team on the Role of Breastfeeding on the Prevention of Infant Mortality, *Effect of breastfeeding on infant and child mortality due to infectious diseases in less developed countries: a pooled analysis.* The Lancet, 2000. **355**: p. 451-455.
59. Rollins, N., *HIV transmission and mortality associated with exclusive breastfeeding: implications for counselling HIV-infected women.*, in *PATH Satellite session, International AIDS Conference.* 2006: Toronto.
60. Coutoudis, A., et al., *Method of feeding and transmission of HIV-1 from mothers to children by 15 months of age: prospective cohort study from Durban, South Africa.* AIDS, 2001. **15**: p. 379-387.
61. Iliff, P.J., et al., *Early exclusive breastfeeding reduces the risk of postnatal HIV-1 transmission and increases HIV-free survival.* Aids, 2005. **19**(7): p. 699-708.

62. Coovadia, H., et al., *Mother-to-child transmission of HIV-1 infection during exclusive breastfeeding in the first 6 months of life: an intervention cohort study.* the Lancet., 2007. **369**: p. 1107-1116.
63. Rollins, N., et al., *Surveillance of mother-to-child transmission prevention programmes at immunization clinics: the case for universal screening.* Aids, 2007. **21**(10): p. 1341-7.
64. WHO., *New data on the Prevention of Mother-to-Child Transmission of HIV and their Policy Implications. Conclusions and recommendations. WHO Technical Consultation on Behalf of the UNFPA/UNICEF/WHO/UNAIDS Inter-Agency Task Team on Mother-to-Child Transmission of HIV.* . 2000 WHO.
65. World Health Organisation. *HIV and infant feeding. Guidelines for decision-maker.* . 2003 [cited 2006 4 October.]; Available from: <http://www.who.int/nutrition/publications/infantfeeding/en/>.
66. World Health Organisation on behalf of the Inter-Agency Task Team, *WHO HIV and Infant Feeding Technical Consultation Held on behalf of the Inter-agency Task Team (IATT) on Prevention of HIV Infections in Pregnant Women, Mothers and their Infants. Geneva, October 25-27, 2006.* 2006, World Health Organisation.
67. World Health Organisation, *The optimal duration of exclusive breastfeeding: Report of an expert consultation, 28-30 March 2001.* 2001, World Health Organisation.
68. Jones, G., et al., *How many child deaths can we prevent this year?* Lancet, 2003. **362**(9377): p. 65-71.
69. Taha, T., et al., *The impact of breastfeeding on the health of HIV-positive mothers and their children in sub-Saharan Africa.* Bulletin of the World Health Organisation, 2006. **84**(7): p. 546-553.
70. Thior, I., et al., *Breastfeeding plus infant zidovudine prophylaxis for 6 months vs formula feeding plus infant zidovudine for 1 month to reduce mother to child transmission of HIV in Botswana. A Randomised Trial: The MASHI study.* JAMA., 2006. **296**(7): p. 794-805.
71. Kuhn, S., Z. Stein, and M. Susser, *Preventing mother-to-child HIV transmission in the new millennium: the challenge of breastfeeding.* Paediatric and Perinatal Epidemiology., 2004. **18**: p. 10-16.
72. Piwoz, E.G. and J.S. Ross, *Use of population-specific infant mortality rates to inform policy decisions regarding HIV and infant feeding.* J Nutr, 2005. **135**(5): p. 1113-9.
73. Coutsooudis, A., et al., *Morbidity in children born to women infected with human immunodeficiency virus in South Africa: does mode of feeding matter?* Acta Paediatr, 2003. **92**(8): p. 890-5.
74. Creek, T., et al., *A large outbreak of diarrhoea among non-breastfed children in Botswana, 2006 - implications for HIV prevention strategies and child health., in Fourteenth conference on retroviruses and opportunistic infections (CROI).* 2007: Los Angeles.
75. Kafulafula, G., et al. *Post-weaning gastroenteritis and mortality in HIV uninfected African infants receiving antiretroviral prophylaxis to prevent MTCT-1 of HIV.* in *Fourteenth conference on retroviruses and opportunistic infections (CROI).* 2004. Los Angeles.
76. Kourtis, A., et al. *Diarrhoea in uninfected infants of HIV-infected mothers who stop breastfeeding at 6 months: The BAN experience.* in *Fourteenth conference on retroviruses and opportunistic infections (CROI).* 2004.

77. Chopra, M., et al., *Preventing HIV transmission to children: An Evaluation of the Quality of Counselling Provided to Mothers in Three PMTCT Pilot Sites in South Africa.* . Acta Paediatrica., 2005. **2005**(94.): p. 357-363.
78. Doherty, T., et al. *An Evaluation of the Prevention of Mother to Child Transmission (PMTCT) of HIV Initiative in South Africa: Outcomes and key recommendations.* . 2003 [cited 2006 13 June]; Available from: [www.hst.org.za](http://www.hst.org.za).
79. Botswana PMTCT Advisory Group, *Evaluation of infant feeding practices by mothers at PMTCT and non-PMTCT sites in Botswana.* , M.o.H. Botswana Food and Nutrition Unit. Family Health Division, Botswana., Editor. 2001.
80. Doherty, T., et al., *Infant feeding choices of HIV-positive women: Do the WHO/UNICEF guidelines improve infant HIV-free survival.* in press - accepted for publication in AIDS., 2007.
81. Doherty, T., et al., *Effectiveness of the WHO/UNICEF guidelines on infant feeding for HIV-positive women: results from a prospective cohort study in South Africa.* AIDS., 2007. **21**.: p. 1791–1797.
82. Doherty, T., et al., *A longitudinal qualitative study of infant-feeding decision making and practices among HIV-positive women in South Africa.* The Journal of Nutrition., 2006. **136**.: p. 2421-2426.
83. Sinkala, M., et al., *No benefit of early cessation of breastfeeding at 4 months on HIV-free survival of infants born to HIV infected mothers in Zambia: the Zambia Exclusive Breastfeeding Study,* in *CROI.* 2006: Los Angeles.
84. Violari, A., et al. *Antiretroviral therapy initiated before 12 weeks of age reduces early mortality in young HIV-infected infants: evidence from the Children with HIV Early Antiretroviral Therapy (CHER) Study. Abstract no. WESS103" in Special session: 4th IAS Conference on HIV Pathogenesis, Treatment and Prevention.* 2007. Sydney, Australia.
85. Newell, M., et al., *Mortality of infected and uninfected infants born to HIV-infected mothers in Africa: a pooled analysis.* Lancet, 2004. **364**((9441)): p. 1236-43.